

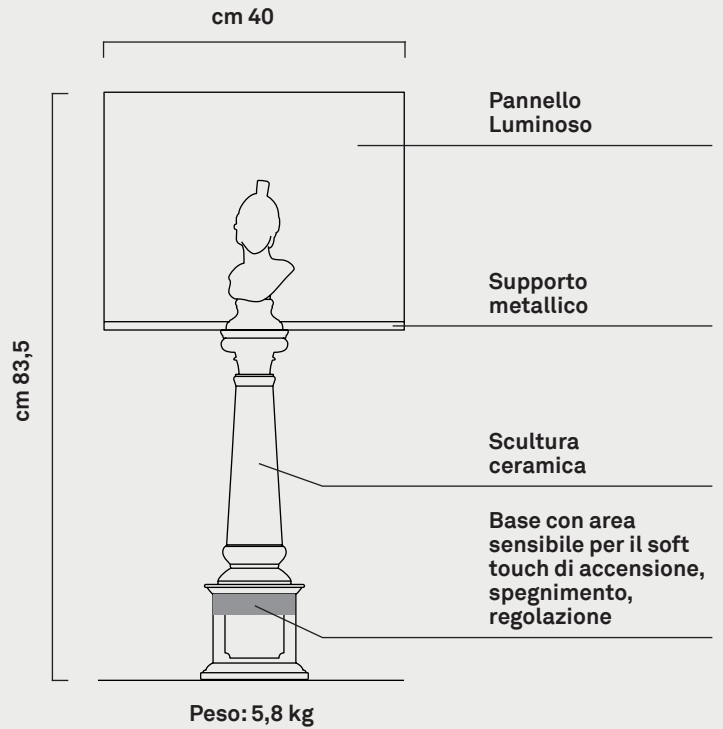

Handmade in Italy

MINERVA TOUCH LAMP



CARATTERISTICHE TECNICHE

Dati tecnici lampada

Assorbimento: 7 W (LED)

Durata led: 50.000 ore

Lumen: 411

Voltaggio: 24Vdc

Grado di protezione: IP 20

Classe di isolamento elettrico: Classe 3^a

Classe energetica: A+

Dati tecnici alimentatore fornito

Tensione di alimentazione: Input 100-240 V, 50-60 Hz; Output 24Vdc

LAMPADA SOLO PER USO INTERNO

 Questo dispositivo è munito di lampade a LED integrate

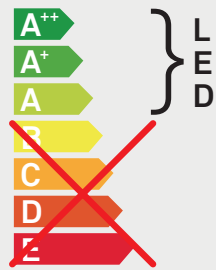



 } LED



Le lampade di questo dispositivo non sono sostituibili

II I 874/2012

ACCENSIONE ELETTRONICA SOFT TOUCH

Modelli disponibili	Colore
Bianca ML-01-W	
Nero lucido ML-02-GB	 Lucido
Oro ML-03-GG	
Argento lucido ML-05-GS	
Nero opaco ML-06-MB	 Opaco

La sigla CE attesta la conformità di questo prodotto alle disposizioni delle direttive comunitarie.



In un'ottica di miglioramento continuo Les First si riserva il diritto e la libertà di apportare modifiche e migliorie ai propri prodotti senza previo preavviso.



Handmade in Italy

MINERVA TOUCH LAMP

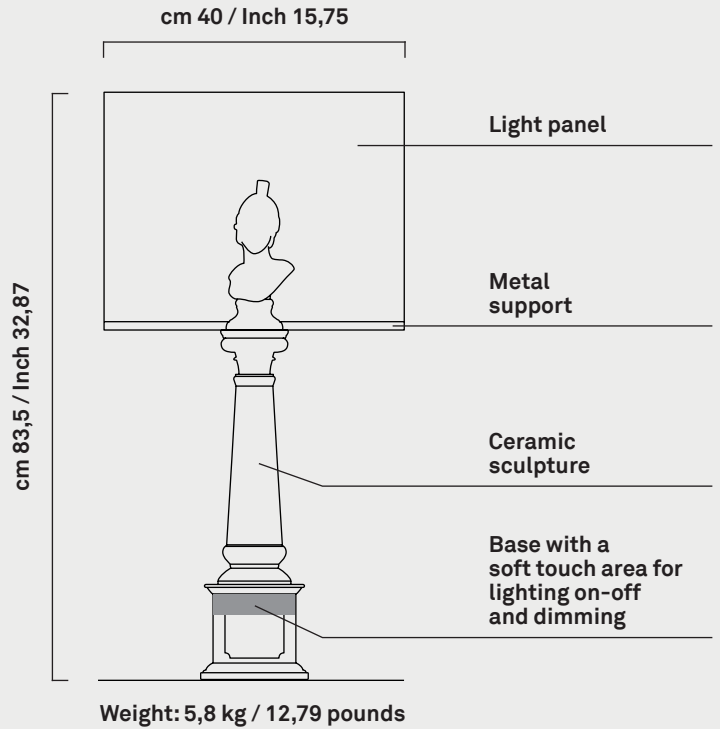

TECHNICAL CHARACTERISTICS

Lamp technical data

Power consumption: 7 W (LED)

LED panel lifespan: 50 000 hours

lm: 411

Voltage: 24VDC

Protection rating: IP 20

Electric insulation class: 3^a

Energetic class: A+

Power supply technical data

Supply voltage: Input 100-240 V, 50-60 Hz; Output 24Vdc

INDOOR USE ONLY

This luminaire contains built-in LED lamps

The lamps in these luminaire cannot be replaced

A++
A+
A
B
C
D
E

LED

II I

874/2012

SOFT TOUCH ELECTRONIC IGNITION

Models available	Colour
White ML-01-W	
Glossy black ML-02-GB	Glossy
Gold ML-03-GG	
Glossy silver ML-05-GS	
Matte black ML-06-MB	Matte

The CE mark guarantees the compliance of this product with applicable EU directives.



As part of its continuous improvement initiative, Les First reserves the right to make modifications and enhancements to its products at any time without notice.